

EN 1092-1 Flanges



EN 1092-1 Flanges Summary Chart

Description		Rated Pressure (in bar)						
		(1 bar = 14.5 psi = 100 kPa)						
		6	10	16	25	40	63	100
01	Plate <slip-on> flanges for welding	V	V	V	V	V	V	V
02	Loose plate flanges with weld-on plate collar	V	V	V	V	V		
04	Loose plate flanges with weld-neck collar	V	V	V	V	V		
05	Blank <blind> flanges	V	V	V	V	V	V	V
11	Weld-Neck Flanges	V	V	V	V	V	V	V
12	Hubbed slip-on flanges for welding	V	V	V	V	V	V	V
13	Hubbed threaded flanges			V		V	V	V
21	Integral flanges	V	V	V	V	V	V	V
32	Weld-on plate collars	V	V	V	V	V		
33	Lapped pipe ends	V	V	V	V	V		
34	Weld-neck collars	V	V	V	V	V		

Flange Facing Dimensions EN 1092-1



Type A: Flat face

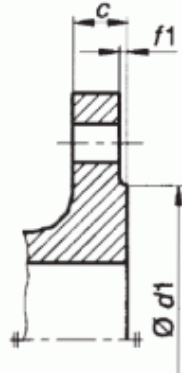

Type B: Raised face (B1 and B2)

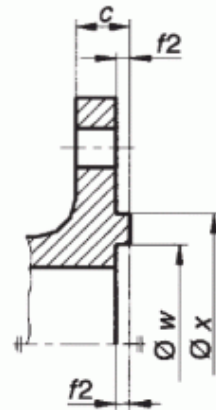

Type C: Tongue

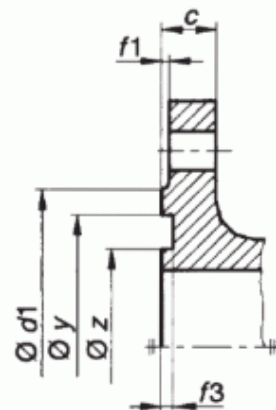

Type D: Groove

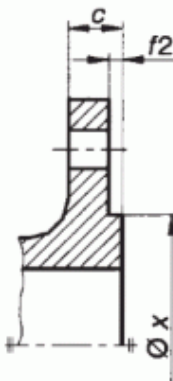

Type E: Spigot

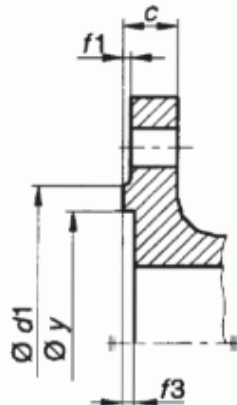

Type F: Recess

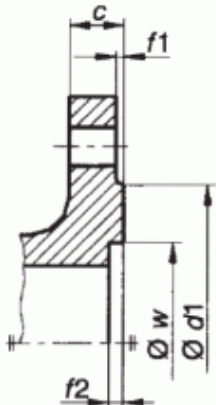

Type G: O-ring spigot

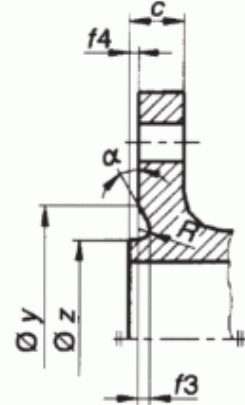

Type H: O-ring groove



Type A
Flat face



Type B
Raised face
(B1 and B2)

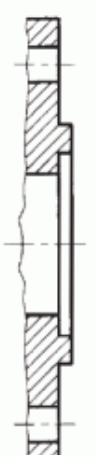

Type C
Tongue



Type D
Groove



Type E
Spigot



Type F
Recess



Type G
O-ring spigot



Type H
O-ring groove

Flange Facing Dimensions EN 1092-1

DN	d_1				f_1	f_2	f_3	f_4	w	x	y	z	$\alpha \approx$	R
	PN 2,5	PN 6	PN 10	PN 16										
	mm	mm	mm	mm										
10	Use PN 6 dimensions	35	Use PN 100 dimensions		2	4,5	4,0	2,0	24	34	35	23	-	2,5
15		40							28					
20		50							35					
25		60							42					
32		70							50					
40		80							60					
50		90	72	5,0		4,5	2,5	73	87	88	72	32°	3	
65		110	94											
80		128	105											
100		148	128											
125		178	154											
150		202	182											
200		258	238	5,5		5,0	3,0	239	259	260	238	27°	3,5	
250		312	291											
300		365	342											
350		415	394											
400	465	446												
450	520	496												
500	570	548	6,5	6,0	4,0	549	575	576	548	28°	4			
600	670	648												
700	775	750												
800	880	855												
900	980	960												
1000	1080	1060												
1200	1280	1260	1480	1510	1530	1262	1292	1294	1260	-	-			
1400	1480	1460												
1600	1690	1660												
1800	1890	1860												
2000	2090	2060												

DN	d_1				f_1	f_2	f_3	f_4	w	x	y	z	$\alpha \approx$	R
	PN 25	PN 40	PN 63	PN 100										
	mm	mm	mm	mm										
10	Use PN 100 dimensions				2	4,5	4,0	2,0	24	34	35	23	-	2,5
15									29	39	40	28		
20									36	50	51	35		
25									43	57	58	42		
32									51	65	66	50		
40									61	75	76	60		
50									73	87	88	72		
65									95	109	110	94		
80	106	120	121	105		5,0	4,5	2,5	129	149	150	128	32°	3
100	162	162	162	162										
125	188	188	188	188										
150	218	218	218	218										
200	278	285	285	285										
250	335	345	345	345										
300	395	410	410	410		5,5	5,0	3,0	343	363	364	342	27°	3,5
350	450	465	465	465										
400	505	535	535	535										
450	555	560	560	560										
500	615	615	615	615										
600	720	735	735	-										
700	820	-	840	-	6,5	6,0	4,0	751	777	778	750	28°	4	
800	930	-	960	-										
900	1030	-	1070	-										
1000	1140	-	1180	-										
1200	1350	-	1380	-										
1400	1560	-	-	-										
1600	1780	-	-	-	1462	1492	1494	1460	-	-				
1800	1985	-	-	-										
2000	2210	-	-	-										

EN 1092-1 PN6 Flanges

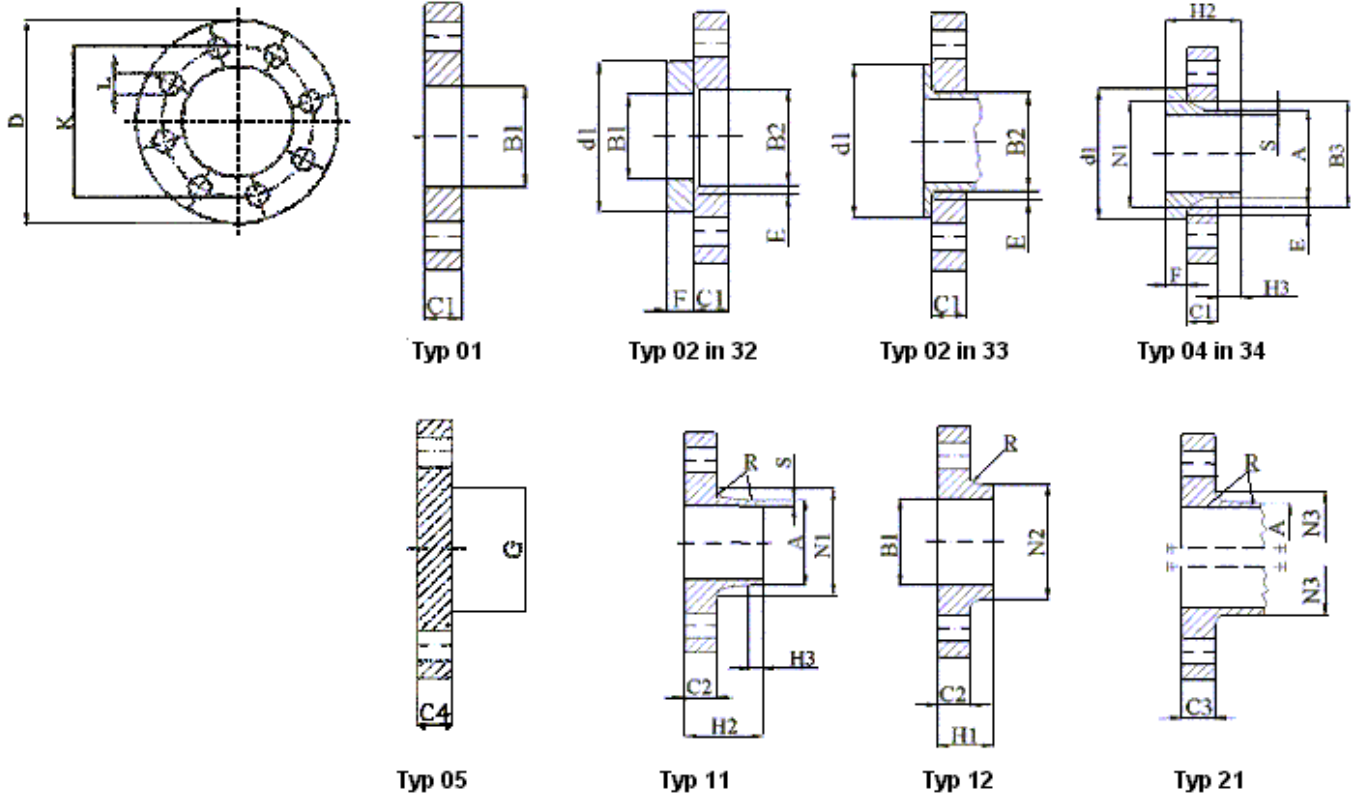

Flange type (typ) as in EN 1092-1	
01 (Plate [slip-on] flanges for welding)	13 (Hubbed threaded flanges)
02 (Loose plate flanges with weld-on plate collar)	21 (Integral flanges)
04 (Loose plate flanges with weld-neck collar)	32 (Weld-on plate collars)
05 (Blank [blind] flanges)	33 (Lapped pipe ends)
11 (Weld-neck flanges)	34 (Weld-neck collars)
12 (Hubbed slip-on flanges for welding)	

EN 1092-1 PN6 Flanges

Nominal diameter DN	Mating dimensions					Outside diameter of neck A	Bore diameters B1 B2			Flange thickness C1* C2 C3 C4				Chamfer E	Collar thickness F	Diameter of shoulder G max	Length H1 H2 H3			Neck diameters N1 N2 N3			Corner radius R	Neck thickness (preferred value) S
	Outside diameter	Diameter of bolt circle	Diameter of bolt hole	Bolts																				
	D	K	L	No	Size																			
	Flange Type																							
01, 02, 05, 11, 12, 13, 21					11 21**	01 12 32	02	01 02 04	11 12 13 21	05	02	32	05	12 13	11	11	11	12 13	21	11 12 12 21	11			
10	75	50	11	4	M10	17,2	18,0	21	12	12	12	3	10	-	20	28	6	26	25	20	4	1,8		
15	80	55	11	4	M10	21,3	22,0	25	12	12	12	3	10	-	20	30	6	30	30	26	4	2,0		
20	90	65	11	4	M10	26,9	27,5	31	14	14	14	4	10	-	24	32	6	38	40	34	4	2,3		
25	100	75	11	4	M10	33,7	34,5	38	14	14	14	4	10	-	24	35	6	42	50	44	4	2,6		
32	120	90	14	4	M12	42,4	43,5	46	16	14	14	5	10	-	26	35	6	55	60	54	6	2,6		
40	130	100	14	4	M12	48,3	49,5	53	16	14	14	5	10	-	26	38	7	62	70	64	6	2,6		
50	140	110	14	4	M12	60,3	61,5	65	16	14	14	5	12	-	28	38	8	74	80	74	6	2,9		
65	160	130	14	4	M12	76,1	77,5	81	16	14	14	6	12	55	32	38	9	88	100	94	6	2,9		
80	190	150	18	4	M16	88,9	90,5	94	18	16	16	6	12	70	34	42	10	102	110	110	8	3,2		
100	210	170	18	4	M16	114,3	116,0	120	18	16	16	6	14	90	40	45	10	130	130	130	8	3,6		
125	240	200	18	8	M16	139,7	141,5	145	20	18	18	6	14	115	44	48	10	155	160	160	8	4,0		
150	265	225	18	8	M16	168,3	170,5	174	20	18	18	6	14	140	44	48	12	184	185	182	10	4,5		
200	320	280	18	8	M16	219,1	221,5	226	22	20	20	6	16	190	44	55	15	236	240	238	10	5,9		
250	375	335	18	12	M16	273,0	276,5	281	24	22	22	8	18	235	44	60	15	290	295	284	12	6,3		
300	440	395	22	12	M20	323,9	327,5	333	24	22	22	8	18	285	44	62	15	342	355	342	12	7,1		
350	490	445	22	12	M20	355,6	359,5	365	26	22	22	8	18	330	-	62	15	385	-	392	12	7,1		
400	540	495	22	16	M20	406,4	411,0	416	28	22	22	8	20	380	-	65	15	438	-	442	12	7,1		
450	595	550	22	16	M20	457,0	462,0	467	30	22	24	8	20	425	-	65	15	492	-	494	12	7,1		
500	645	600	22	20	M20	508,0	513,5	519	30	24	24	8	22	475	-	68	15	538	-	544	12	7,1		
600	755	705	26	20	M24	610,0	616,5	622	32	30	30	8	22	575	-	70	16	640	-	642	12	7,1		
700	860	810	26	24	M24	711,0	-	-	-	24	40	-	-	670	-	70	16	740	-	746	12	7,1		
800	975	920	30	24	M27	813,0	-	-	-	24	44	-	-	770	-	70	16	842	-	850	12	7,1		
900	1075	1020	30	24	M27	914,0	-	-	-	26	48	-	-	860	-	70	16	942	-	950	12	7,1		
1000	1175	1120	30	28	M27	1016,0	-	-	-	26	52	-	-	960	-	70	16	1045	-	1050	16	7,1		
1200	1405	1340	33	32	M30	1219,0	-	-	-	28	60	-	-	1160	-	90	20	1248	-	1264	16	8,0		
1400	1630	1560	36	36	M33	1422,0	-	-	-	32	68	-	-	1346	-	90	20	1452	-	1480	16	8,0		
1600	1830	1760	36	40	M33	1626,0	-	-	-	34	76	-	-	1546	-	90	20	1655	-	1680	16	9,0		
1800	2045	1970	39	44	M36	1829,0	-	-	-	36	84	-	-	1746	-	100	20	1855	-	1878	16	10,0		
2000	2265	2180	42	48	M39	2032,0	-	-	-	38	92	-	-	1950	-	110	25	2058	-	2082	16	11,0		
2200	2475	2390	42	52	M39	2035,0	-	-	-	42	-	-	-	-	-	115	25	2260	-	-	18	12,0		
2400	2685	2600	42	56	M39	2438,0	-	-	-	44	-	-	-	-	-	125	25	2462	-	-	18	13,0		
2600	2905	2710	48	60	M45	2620,0	-	-	-	46	-	-	-	-	-	130	25	2665	-	-	18	14,0		
2800	3115	3020	48	64	M45	2820,0	-	-	-	48	-	-	-	-	-	135	30	2865	-	-	18	15,0		
3000	3315	3220	48	68	M45	3020,0	-	-	-	50	-	-	-	-	-	140	30	3068	-	-	18	16,0		
3200	3525	3430	48	72	M45	3220,0	-	-	-	54	-	-	-	-	-	150	30	3272	-	-	20	16,0		
3400	3735	3640	48	76	M45	3420,0	-	-	-	56	-	-	-	-	-	160	35	3475	-	-	20	18,0		
3600	3970	3860	56	80	M52	3620,0	-	-	-	60	-	-	-	-	-	165	35	3678	-	-	20	18,0		

Note 1: Dimensions N1, N2 and N3 are measured at the intersection of the hub draft angle and the back face of the flange.

Note 2: For d1 dimensions see document "Flange Facing Dimensions EN 1092-1".

EN 1092-1 PN10 Flanges

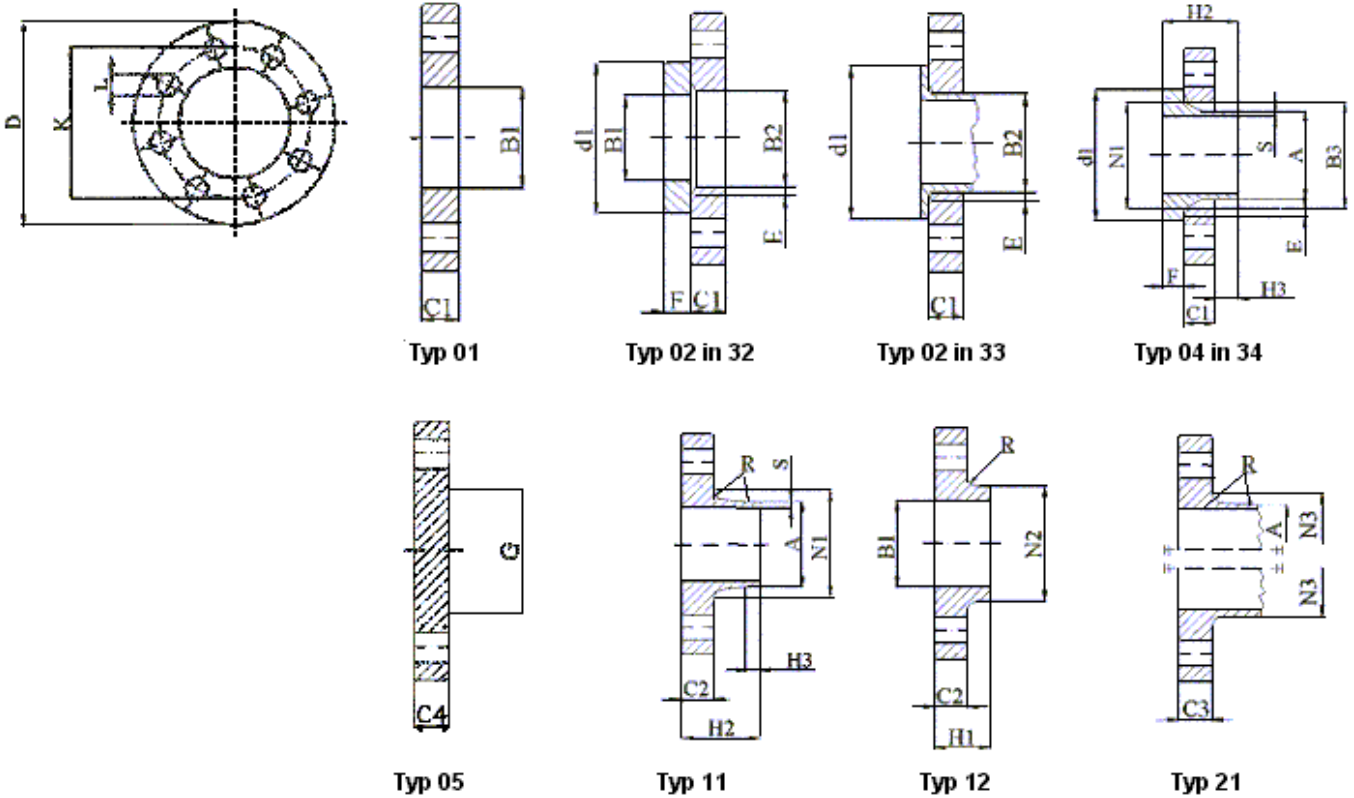

Flange type (typ) as in EN 1092-1	
01 (Plate [slip-on] flanges for welding)	13 (Hubbed threaded flanges)
02 (Loose plate flanges with weld-on plate collar)	21 (Integral flanges)
04 (Loose plate flanges with weld-neck collar)	32 (Weld-on plate collars)
05 (Blank [blind] flanges)	33 (Lapped pipe ends)
11 (Weld-neck flanges)	34 (Weld-neck collars)
12 (Hubbed slip-on flanges for welding)	

EN 1092-1 PN10 Flanges

Nominal diameter DN	Mating dimensions					Outside diameter of neck	Bore diameters				Flange thickness				Chamfer	Collar thickness	Diameter of shoulders	Length			Neck diameters			Corner radius	Neck thickness (preferred value)																			
	Outside diameter	Diameter of bolt circle of bolt circle	Diameter of bolt hole	Bolting																																								
	D	K	L	No	Size																					A	B1	B2	B3	C1	C2	C3	C4	E	F	G max.	H1	H2	H3	N1	N2	N3	R	S
	Flange Type																									11	01	02	04	01	11	05	02	32	05	12	11	11	11	12	21	11	11	
	01, 02, 05, 11, 12, 21					21*	12	02	04	02	12	21	04	34	05		34	34	34	34	21	21	12	34																				
10 15 20 25 32 40	Use PN40 dimensions	Use PN40 dimensions																																										
50 65 80 100 125 150	Use PN 16 dimensions	Use PN 16 dimensions																																										
200	340	295	22	8	M20	219,1	221,5	226	240	24	24	24	24	6	20	190	44	62	16	234	246	246	10	5,9																				
250	395	350	22	12	M20	273,0	276,5	218	294	26	26	26	26	8	22	235	46	68	16	292	298	298	12	6,3																				
300	445	400	22	12	M20	323,9	327,5	333	348	26	26	26	26	8	22	285	46	68	16	342	350	348	12	7,1																				
350	505	460	22	16	M20	335,6	359,5	365	400	28	26	26	26	8	22	330	53	68	16	385	400	408	12	7,1																				
400	565	515	26	16	M24	406,4	411,0	416	450	32	26	26	26	8	24	380	57	72	16	440	456	456	12	7,1																				
450	615	565	26	20	M24	457,0	462,0	467	498	36	28	28	28	8	24	425	63	72	16	488	502	502	12	7,1																				
500	670	620	26	20	M24	508,0	513,5	519	550	38	28	28	28	8	26	475	67	75	16	542	559	559	12	7,1																				
600	780	725	30	20	M27	610,0	616,5	622	650	42	34	34	34	8	26	575	75	80	18	642	658	658	12	7,1																				
700	895	840	30	24	M27	711,1	-	-	-	-	30	34	38	-	-	670	-	80	18	746	-	772	12	8,0																				
800	1015	950	33	24	M30	813	-	-	-	-	32	36	42	-	-	770	-	90	18	850	-	876	12	8,0																				
900	1115	1050	33	28	M30	914	-	-	-	-	34	38	46	-	-	860	-	95	20	950	-	976	12	10,0																				
1000	1230	1160	36	28	M33	1016	-	-	-	-	34	38	52	-	-	960	-	95	20	1052	-	1080	16	10,0																				
1200	1455	1380	39	32	M36	1219	-	-	-	-	38	44	60	-	-	1160	-	115	25	1256	-	1292	16	11,0																				
1400	1675	1590	42	36	M39	1422	-	-	-	-	42	48	-	-	-	1346	-	120	25	1460	-	1496	16	12,0																				
1600	1915	1820	48	40	M45	1626	-	-	-	-	46	52	-	-	-	1546	-	130	25	1666	-	1712	16	14,0																				
1800	2115	2020	48	44	M45	1829	-	-	-	-	50	56	-	-	-	1746	-	140	30	1868	-	1910	16	15,0																				
2000	2325	2230	48	48	M45	2032	-	-	-	-	54	60	-	-	-	1950	-	150	30	2072	-	2120	16	16,0																				
2200	2550	2440	56	52	M52	2235	-	-	-	-	58	-	-	-	-	-	-	160	35	2275	-	-	18	18,0																				
2400	2760	2650	56	56	M52	2438	-	-	-	-	62	-	-	-	-	-	-	170	35	2478	-	-	18	20,0																				
2600	2960	2850	56	60	M52	2620	-	-	-	-	66	-	-	-	-	-	-	180	40	2680	-	-	18	22,0																				
2800	3180	3070	56	64	M52	2820	-	-	-	-	70	-	-	-	-	-	-	190	40	2882	-	-	18	22,0																				
3000	3405	3290	62	68	M56	3020	-	-	-	-	75	-	-	-	-	-	-	200	45	3085	-	-	18	24,0																				

Note 1: Dimensions N1, N2 and N3 are measured at the intersection of the hub draft angle and the back face of the flange.

Note 2: For d1 dimensions see document "Flange Facing Dimensions EN 1092-1".

EN 1092-1 PN16 Flanges

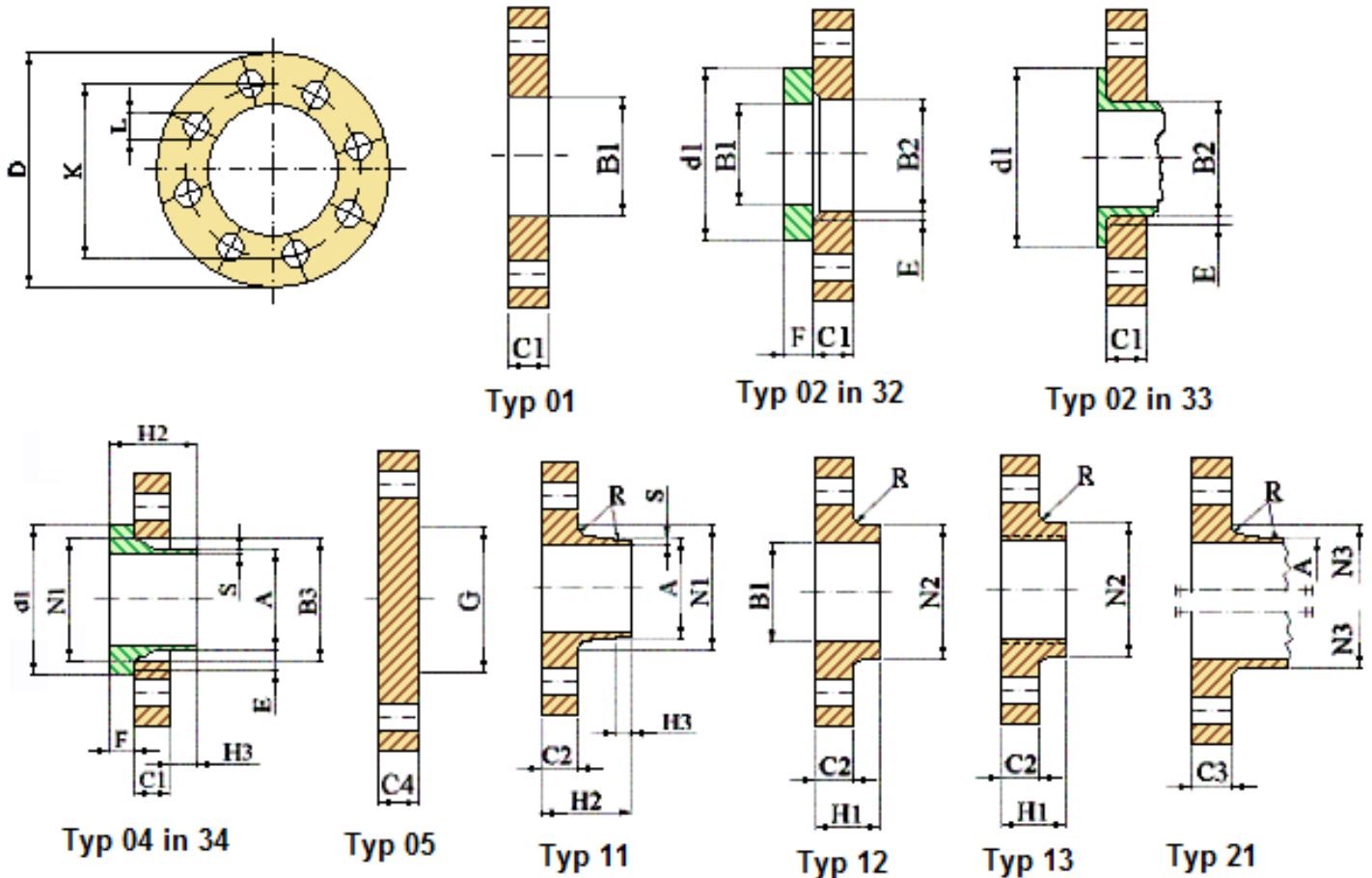

Flange type (typ) as in EN 1092-1	
01 (Plate [slip-on] flanges for welding)	13 (Hubbed threaded flanges)
02 (Loose plate flanges with weld-on plate collar)	21 (Integral flanges)
04 (Loose plate flanges with weld-neck collar)	32 (Weld-on plate collars)
05 (Blank [blind] flanges)	33 (Lapped pipe ends)
11 (Weld-neck flanges)	34 (Weld-neck collars)
12 (Hubbed slip-on flanges for welding)	

EN 1092-1 PN16 Flanges

Nominal diameter DN	Mating dimensions					Outside diameter of neck	Bore diameters			Flange thickness				Chamfer	Collar thickness	Diameter of shoulders	Length			Neck diameters			Corner radius	Neck thickness (preferred value)																			
	Outside diameter	Diameter of bolt circle	Diameter of bolt hole	Bolting																																							
	D	K	L	No	Size																				A	B1	B2	B3	C1	C2	C3	C4	E	F	G max.	H1	H2	H3	N1	N2	N3	R	S
	Flange Type																																										
	01, 02, 05, 11, 12, 21					11 21* 34	01 12 32	02	04	01 02 04	11 12 13	21	05	02 04	32 34	05	12 13	11 34	11 34	11 34	12 13	21	11 12 13 21	11 34																			
10 15 20 25 32 40	Use PN 40 dimensions																																										
50	165	125	18	4	M16	60,3	61,5	65	77	19	18	18	18	5	16	-	28	45	8	74	84	84	5	2,9																			
65	185	145	18	**	M16	76,1	77,5	81	96	20	18	18	18	6	16	55	32	45	10	92	104	104	6	2,9																			
80	200	160	18	8	M16	88,9	90,5	94	108	20	20	20	20	6	16	70	34	50	10	105	118	120	6	3,2																			
100	220	180	18	8	M16	114,3	116,0	120	134	22	20	20	20	6	18	90	40	52	12	131	140	140	8	3,6																			
125	250	210	18	8	M16	139,7	141,5	145	162	22	22	22	22	6	18	115	44	55	12	156	168	170	8	4,0																			
150	285	240	22	8	M20	168,3	170,5	174	188	24	22	22	22	6	20	140	44	55	12	184	195	190	10	4,5																			
200	340	295	22	12	M20	219,1	221,5	226	240	26	24	24	24	6	20	190	44	62	16	235	246	246	10	5,9																			
250	405	355	26	12	M24	273,0	276,5	281	294	29	26	26	26	8	22	235	46	70	16	292	298	296	12	6,3																			
300	460	410	26	12	M24	323,9	327,5	333	348	32	28	28	28	8	24	285	46	78	16	344	350	350	12	7,1																			
350	520	470	26	16	M24	355,6	359,0	365	400	35	30	30	30	8	26	330	57	82	16	390	400	410	12	8,0																			
400	580	525	30	16	M27	406,4	411,0	416	454	38	32	32	32	8	28	380	63	85	16	445	456	458	12	8,0																			
450	640	585	30	20	M27	457,0	462,0	467	500	42	40	40	40	8	30	425	68	87	16	490	502	516	12	8,0																			
500	715	650	33	20	M30	508,0	513,5	510	556	46	44	44	44	8	32	475	73	90	16	548	559	576	12	8,0																			
600	840	770	36	20	M33	610,0	616,5	622	660	52	54	54	54	8	32	575	83	95	18	652	658	690	12	8,8																			
700	910	840	36	24	M33	711,0	-	-	-	-	36	42	48	-	-	670	83	100	18	755	760	760	12	8,8																			
800	1025	950	39	24	M36	813,0	-	-	-	-	38	42	52	-	-	770	90	105	20	855	864	862	12	10,0																			
900	1125	1050	39	28	M36	914,0	-	-	-	-	40	44	58	-	-	860	94	110	20	955	968	962	12	10,0																			
1000	1255	1170	42	28	M39	1016,0	-	-	-	-	42	46	64	-	-	960	100	120	22	1058	1072	1076	16	10,0																			
1200	1485	1390	48	32	M45	1219,0	-	-	-	-	48	52	76	-	-	1160	-	130	30	1262	-	1282	16	12,5																			
1400	1685	1590	48	36	M45	1422,0	-	-	-	-	52	58	-	-	-	1346	-	145	30	1465	-	1482	16	14,2																			
1600	1930	1820	56	40	M52	1626,0	-	-	-	-	58	64	-	-	-	1546	-	160	35	1668	-	1696	16	16,0																			
1800	2130	2020	56	44	M52	1829,0	-	-	-	-	62	68	-	-	-	1746	-	170	35	1870	-	1896	16	17,5																			
2000	2345	2230	62	48	M56	2032,0	-	-	-	-	66	70	-	-	-	1950	-	180	40	2072	-	2100	16	20,0																			

Note 1: Dimensions N1, N2 and N3 are measured at the intersection of the hub draft angle and the back face of the flange.

Note 2: For d1 dimensions see document "Flange Facing Dimensions EN 1092-1".

EN 1092-1 PN25 Flanges

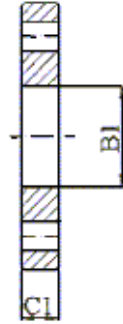
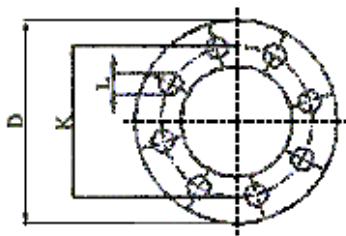

Typ 01

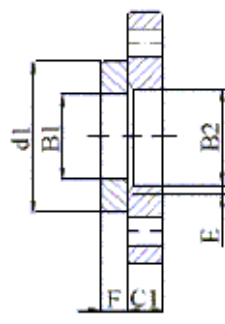

Typ 02 in 32

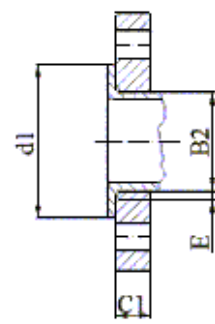

Typ 02 in 33

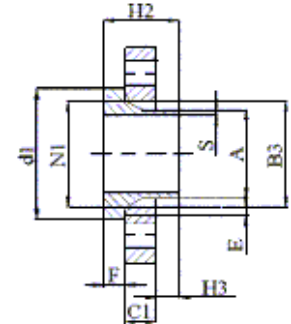

Typ 04 in 34



Typ 05

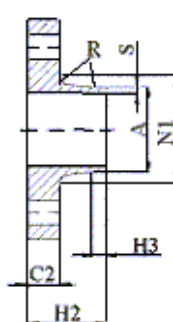

Typ 11

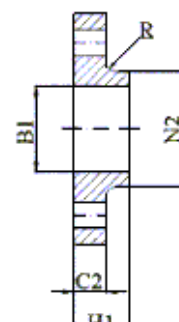

Typ 12

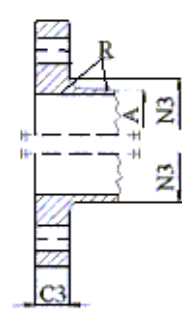

Typ 21

Flange type (typ) as in EN 1092-1	
01 (Plate [slip-on] flanges for welding)	13 (Hubbed threaded flanges)
02 (Loose plate flanges with weld-on plate collar)	21 (Integral flanges)
04 (Loose plate flanges with weld-neck collar)	32 (Weld-on plate collars)
05 (Blank [blind] flanges)	33 (Lapped pipe ends)
11 (Weld-neck flanges)	34 (Weld-neck collars)
12 (Hubbed slip-on flanges for welding)	

EN 1092-1 PN25 Flanges

Nominal diameter DN	Mating dimensions					Outside diameter of neck	Bore diameters			Flange thickness				Chamfer	Collar thickness	Diameter of shoulder	Length			Neck diameters			Corner radius	Neck thickness (preferred value)																			
	Outside diameter	Diameter of bolt circle	Diameter of bolt hole	Bolts																																							
	D	K	L	No	Size																				A	B1	B2	B3	C1	C2	C3	C4	E	F	G _{max}	H1	H2	H3	N1	N2	N3	R	S
	Flange Type																																										
01, 02, 05, 11, 12, 21					11 21* 34	01 12 32	02	04	01 02 04	11 12 13	21	05	02 04	32 34	05	12 13	11 34	11 34	11 34	12 13	21	11 12 13 21	11 34																				
10	Use PN 40 dimensions																																										
15																																											
20																																											
25																																											
32																																											
40																																											
50																																											
65																																											
80																																											
100																																											
125																																											
150																																											
200	360	310	26	12	M24	219,1	221,5	226	250	32	30	30	30	6	26	190	52	80	16	244	256	252	10	6,3																			
250	425	370	30	12	M27	273,5	276,5	281	302	35	32	32	32	8	26	235	60	88	18	298	310	304	12	7,1																			
300	485	430	30	16	M27	323,9	327,5	333	356	38	34	34	34	8	28	285	67	92	18	352	364	364	12	8,0																			
350	555	490	33	16	M30	355,6	359,5	365	408	42	38	38	38	8	32	332	72	100	20	398	418	418	12	8,0																			
400	620	550	36	16	M33	406,4	411,0	416	462	46	40	40	40	8	34	380	78	110	20	452	472	472	12	8,8																			
450	670	600	36	20	M33	457,0	462,0	467	510	50	46	46	46	8	36	425	84	110	20	500	520	520	12	8,8																			
500	730	660	36	20	M33	508,0	513,5	519	568	56	48	48	48	8	38	475	90	125	20	558	580	580	12	10,0																			
600	845	770	39	20	M36	610,0	616,5	622	670	68	58	58	58	8	40	575	100	125	20	660	684	684	12	11,0																			
700	960	875	42	24	M39	711,0	-	-	-	-	46	50	-	-	-	-	-	125	20	760	-	780	12	12,5																			
800	1085	990	48	24	M45	813,0	-	-	-	-	50	54	-	-	-	-	-	135	22	864	-	882	12	14,2																			
900	1158	1090	48	28	M45	914,0	-	-	-	-	54	58	-	-	-	-	-	145	24	968	-	982	12	16,0																			
1000	1320	1210	56	28	M52	1016,0	-	-	-	-	58	62	-	-	-	-	-	155	24	1070	-	1086	16	17,5																			
1200	1530	1420	56	32	M52	1219	-	-	-	-	-	70	-	-	-	-	-	-	-	-	-	1296	18	-																			
1400	1755	1640	62	36	M56	1422	-	-	-	-	-	76	-	-	-	-	-	-	-	-	-	1508	18	-																			
1600	1975	1860	62	40	M56	1626	-	-	-	-	-	84	-	-	-	-	-	-	-	-	-	1726	20	-																			
1800	2195	2070	70	44	M64	1829	-	-	-	-	-	90	-	-	-	-	-	-	-	-	-	1920	20	-																			
2000	2425	2300	70	48	M64	2032	-	-	-	-	-	96	-	-	-	-	-	-	-	-	-	2150	20	-																			

Note 1: Dimensions N1, N2 and N3 are measured at the intersection of the hub draft angle and the back face of the flange.

Note 2: For d1 dimensions see document " Flange Facing Dimensions EN 1092-1".

EN 1092-1 PN40 Flanges

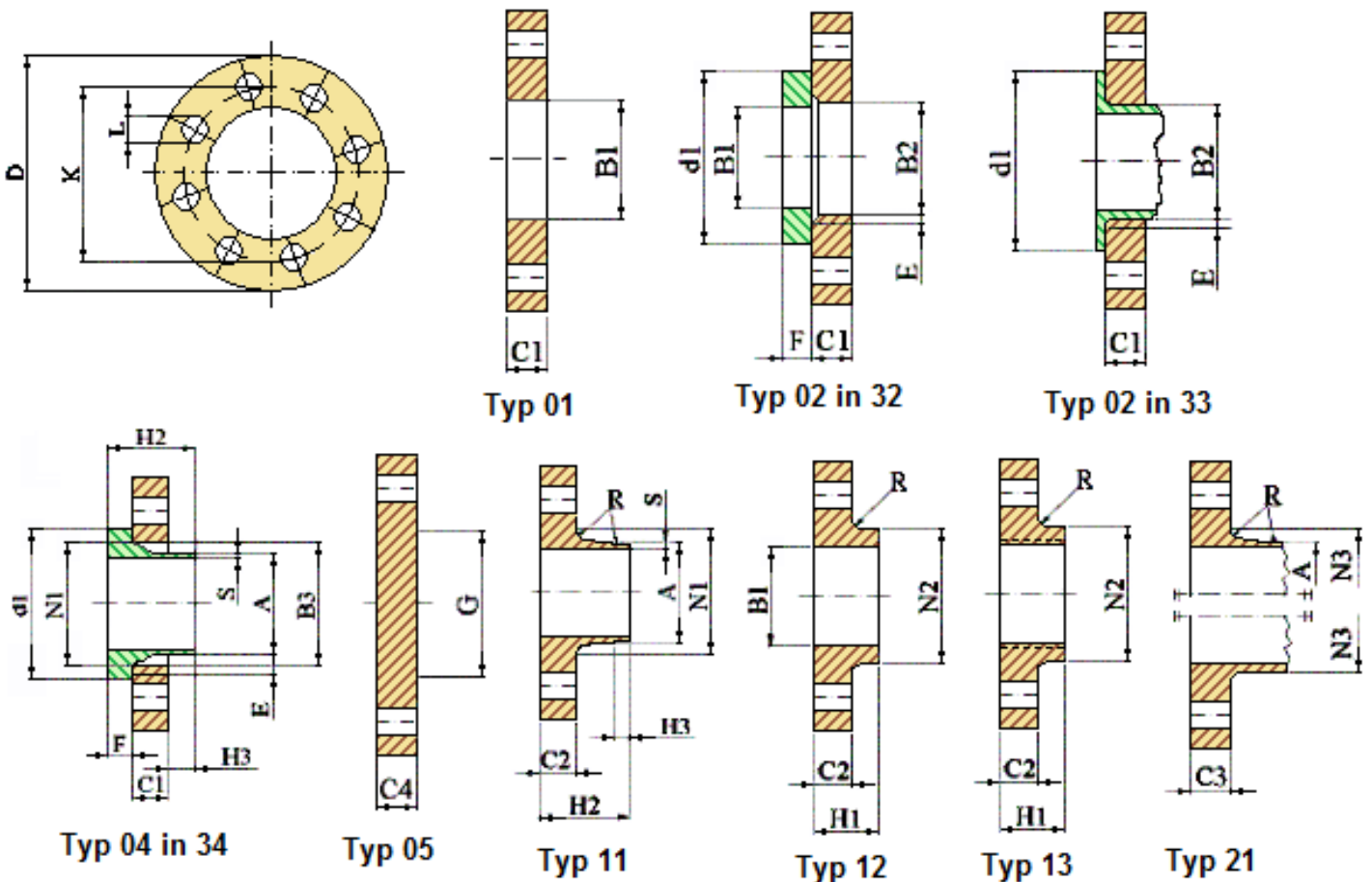

Flange type (typ) as in EN 1092-1	
01 (Plate [slip-on] flanges for welding)	13 (Hubbed threaded flanges)
02 (Loose plate flanges with weld-on plate collar)	21 (Integral flanges)
04 (Loose plate flanges with weld-neck collar)	32 (Weld-on plate collars)
05 (Blank [blind] flanges)	33 (Lapped pipe ends)
11 (Weld-neck flanges)	34 (Weld-neck collars)
12 (Hubbed slip-on flanges for welding)	

EN 1092-1 PN40 Flanges

Nominal diameter DN	Mating dimensions						Outside diameter of neck A	Bore diameters B1 B2 B3			Flange thickness C1 C2 C3 C4				Chamfer E	Collar thickness F	Diameter of shoulders G max	Length H1 H2 H3			Neck diameters N1 N2 N3			Corner radius R	Neck thickness (preferred value) S
	Outside diameter	Diameter of bolt circle	Diameter of bolt hole	Bolting																					
	D	K	L	No	Size																				
	Flange Type																								
01, 02, 05, 11, 12, 13, 21						11 21* 34	01 12 32	02	04	01 02 04	11 12 13	21	05	02 04	32 34	05	12 13	11 34	11 34	11 34	12 13	21	11 12 13 21	11 34	
10	90	60	14	4	M12	17,2	18,0	21	31	14	16	16	3	12	-	22	35	6	28	30	28	4	1,8		
15	95	65	14	4	M12	21,3	22,0	25	35	14	16	16	3	12	-	22	38	6	32	35	32	4	2,0		
20	105	75	14	4	M12	26,9	27,5	31	42	16	18	18	4	14	-	26	40	6	40	45	40	4	2,3		
25	115	85	14	4	M12	33,7	34,5	38	49	16	18	18	4	14	-	28	40	6	46	52	52	4	2,6		
32	140	100	18	4	M16	42,4	43,5	47	59	18	18	18	5	14	-	30	42	6	56	60	60	6	2,6		
40	150	110	18	4	M16	48,3	49,5	53	67	18	18	18	5	14	-	32	45	7	64	70	70	6	2,6		
50	165	125	18	4	M16	60,3	61,5	65	77	20	20	20	5	16	-	34	48	8	75	84	84	6	2,9		
65	185	145	18	8	M16	76,1	77,5	81	96	22	22	22	6	16	55	38	52	10	90	104	104	6	2,9		
80	200	160	18	8	M16	88,9	90,5	94	114	24	24	24	6	18	70	40	58	12	105	118	120	8	3,2		
100	235	190	22	8	M20	114,3	116,0	120	138	26	24	24	6	20	90	44	65	12	134	145	142	8	3,6		
125	270	220	26	8	M24	139,7	141,5	145	166	28	26	26	6	22	115	48	68	12	162	170	162	8	4,0		
150	300	250	26	8	M24	168,3	170,5	174	194	30	28	28	6	24	140	52	75	12	192	200	192	10	4,5		
200	375	320	30	12	M27	219,1	221,5	226	250	36	34	36	6	28	190	52	88	16	244	260	254	10	6,3		
250	450	385	33	12	M30	273,0	276,5	281	312	42	38	38	8	30	235	60	105	18	306	312	312	12	7,1		
300	515	450	33	16	M30	323,9	327,5	333	368	48	42	42	8	34	285	67	115	18	362	380	378	12	8,0		
350	580	510	36	16	M33	355,6	359,5	365	418	54	46	46	8	36	330	72	125	20	408	424	432	12	8,8		
400	660	585	39	16	M36	406,4	411,0	416	472	60	50	50	8	42	380	78	135	20	462	478	498	12	11,0		
450	685	610	39	20	M36	457,0	462,0	467	510	66	57	57	8	46	425	84	135	20	500	522	522	12	12,5		
500	755	670	42	20	M39	508,0	513,5	519	572	72	57	57	8	50	475	90	140	20	562	576	576	12	14,2		
600	890	795	48	20	M45	610,0	616,5	622	676	84	72	72	8	54	575	100	150	20	666	686	686	12	16,0		

Note 1: Dimensions N1, N2 and N3 are measured at the intersection of the hub draft angle and the back face of the flange.

Note 2: For d1 dimensions see document "Flange Facing Dimensions EN 1092-1".

EN 1092-1 PN63 Flanges

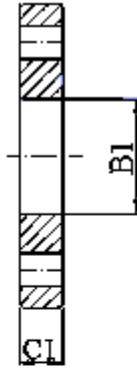
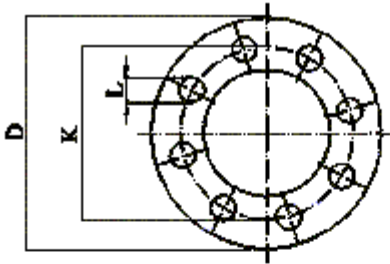

Typ 01

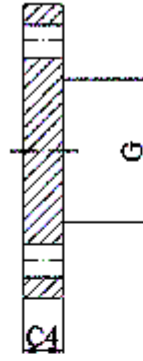

Typ 05

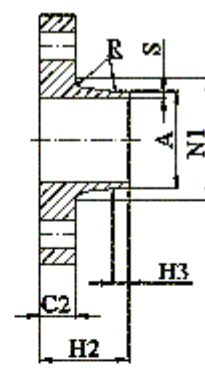

Typ 11

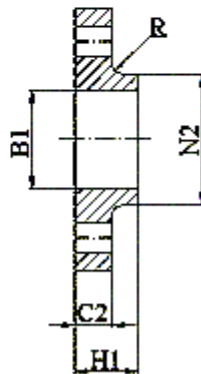

Typ 12

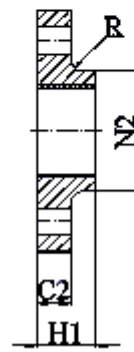

Typ 13

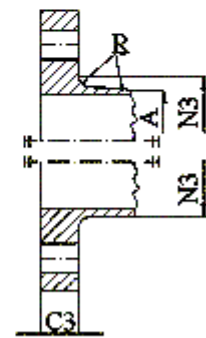

Typ 21

Flange type (typ) as in EN 1092-1	
01 (Plate [slip-on] flanges for welding)	13 (Hubbed threaded flanges)
02 (Loose plate flanges with weld-on plate collar)	21 (Integral flanges)
04 (Loose plate flanges with weld-neck collar)	32 (Weld-on plate collars)
05 (Blank [blind] flanges)	33 (Lapped pipe ends)
11 (Weld-neck flanges)	34 (Weld-neck collars)
12 (Hubbed slip-on flanges for welding)	

EN 1092-1 PN63 Flanges

Nominal diameter DN	Mating dimensions				Bolting	Outside diameter of neck	Bore diameters			Flange thickness				Chamfer	Collar thickness	Diameter of shoulders	Length			Neck diameters			Corner radius	Neck thickness (preferred value)																				
	Outside diameter	Diameter of bolt circle	Diameter of bolt hole																																									
	D	K	L	No																					Size	A	B1	B2	B3	C1	C2	C3	C4	E	F	G max	H1	H2	H3	N1	N2	N3	R	S
	Flange Type																																											
01, 05, 11, 12, 13, 21				11 21*	01 12	-	-	01	11 12 13	21	05	-	-	05	12 13	11	11	11	11	12 13	21	11 12 13 21	11																					
10	Use PN 100 dimensions																																											
15	Use PN 100 dimensions																																											
20	Use PN 100 dimensions																																											
25	Use PN 100 dimensions																																											
32	Use PN 100 dimensions																																											
40	Use PN 100 dimensions																																											
50	180	135	22	4	M20	60,3	61,5	-	-	26	26	26	26	-	-	-	36	62	10	82	90	90	6	2,9																				
65	205	160	22	8	M20	76,1	77,5	-	-	26	26	26	26	-	-	45	40	68	12	98	112	105	6	3,2																				
80	215	170	22	8	M20	88,9	90,5	-	-	30	28	28	28	-	-	60	44	72	12	112	125	122	8	3,6																				
100	250	200	26	8	M24	114,3	116,0	-	-	32	30	30	30	-	-	80	52	78	12	138	152	146	8	4,0																				
125	295	240	30	8	M27	139,7	141,5	-	-	34	34	34	34	-	-	105	56	88	12	168	185	177	8	4,5																				
150	345	280	33	8	M30	168,3	170,5	-	-	36	36	36	36	-	-	130	60	95	12	202	215	204	10	5,6																				
200	415	345	36	12	M33	219,1	221,5	-	-	46	42	42	42	-	-	180	-	110	16	256	-	264	10	7,1																				
250	470	400	36	12	M33	273,0	276,5	-	-	54	46	46	46	-	-	220	-	125	18	316	-	320	12	8,8																				
300	530	460	36	16	M33	323,9	327,5	-	-	62	52	52	52	-	-	270	-	140	18	372	-	378	12	11,0																				
350	600	525	39	16	M36	355,6	359,5	-	-	72	56	56	56	-	-	310	-	150	20	420	-	434	12	12,5																				
400	670	585	42	16	M39	406,4	411,0	-	-	78	60	60	60	-	-	360	-	160	20	475	-	490	12	14,2																				
500	800	705	48	20	M45	-	-	-	-	-	-	68	-	-	-	-	-	-	-	-	-	602	12	-																				
600	930	820	56	20	M52	-	-	-	-	-	-	76	-	-	-	-	-	-	-	-	-	714	15	-																				
700	1045	935	56	24	M52	-	-	-	-	-	-	84	-	-	-	-	-	-	-	-	-	826	15	-																				
800	1165	1050	62	24	M56	-	-	-	-	-	-	92	-	-	-	-	-	-	-	-	-	938	18	-																				
900	1285	1170	62	28	M56	-	-	-	-	-	-	98	-	-	-	-	-	-	-	-	-	1048	18	-																				
1000	1415	1290	70	28	M64	-	-	-	-	-	-	108	-	-	-	-	-	-	-	-	-	1162	18	-																				
1200	1665	1530	78	32	M72	-	-	-	-	-	-	126	-	-	-	-	-	-	-	-	-	1390	18	-																				

Note 1: Dimensions N1, N2 and N3 are measured at the intersection of the hub draft angle and the back face of the flange.

EN 1092-1 PN100 Flanges

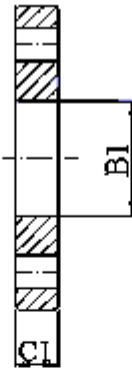
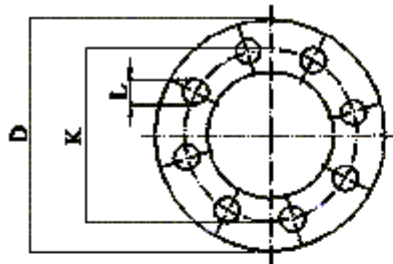

Typ 01



Typ 05

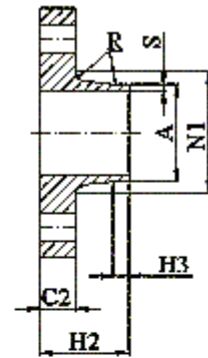

Typ 11

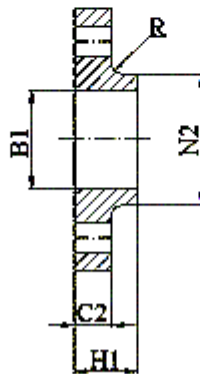

Typ 12

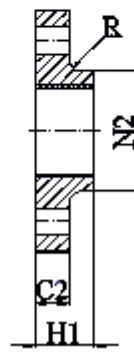

Typ 13

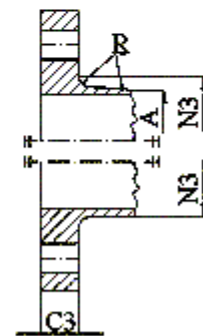

Typ 21

Flange type (typ) as in EN 1092-1	
01 (Plate [slip-on] flanges for welding)	13 (Hubbed threaded flanges)
02 (Loose plate flanges with weld-on plate collar)	21 (Integral flanges)
04 (Loose plate flanges with weld-neck collar)	32 (Weld-on plate collars)
05 (Blank [blind] flanges)	33 (Lapped pipe ends)
11 (Weld-neck flanges)	34 (Weld-neck collars)
12 (Hubbed slip-on flanges for welding)	

EN 1092-1 PN100 Flanges

Nominal diameter DN	Mating dimensions					Outside diameter of neck	Bore diameters			Flange thickness				Chamber	Collar thickness	Diameter of shoulders	Length			Neck diameters			Corner radius	Neck thickness (preferred value)																			
	Outside diameter	Diameter of bolt circle	Diameter of bolt hole	Bolting																																							
	D	K	L	Num	Size																				A	B1	B2	B3	C1	C2	C3	C4	E	F	G max.	H1	H2	H3	N1	N2	N3	R	S
	Flange type																								11 21*	01 12	-	-	01	11 12 13	21	05	-	-	05	12 13	11	11	11	12 13	21	11 12 13 21	11
10	100	70	14	4	M12	17,2	18,0	-	-	20	20	20	20	-	-	-	28	45	6	32	40	40	4	1,8																			
15	105	75	14	4	M12	21,3	22,0	-	-	20	20	20	20	-	-	-	28	45	6	34	43	45	4	2,0																			
20	130	90	18	4	M16	26,9	27,5	-	-	22	22	22	22	-	-	-	30	48	8	42	52	50	4	2,6																			
25	140	100	18	4	M16	33,7	34,5	-	-	24	24	24	24	-	-	-	32	58	8	52	60	61	4	2,6																			
32	155	110	22	4	M20	42,4	43,5	-	-	24	24	26	24	-	-	-	32	60	8	62	68	68	6	2,9																			
40	170	125	22	4	M20	48,3	49,5	-	-	26	26	28	26	-	-	-	34	62	10	70	80	82	6	2,9																			
50	195	145	26	4	M24	60,3	61,3	-	-	28	28	30	28	-	-	-	36	68	10	90	95	96	6	3,2																			
65	220	170	26	8	M24	76,1	77,5	-	-	30	30	34	30	-	-	45	40	76	12	108	118	118	6	3,6																			
80	230	180	26	8	M24	88,9	90,5	-	-	34	32	36	32	-	-	60	44	78	12	120	130	128	8	4,0																			
100	265	210	30	8	M27	114,3	116,0	-	-	36	36	40	36	-	-	80	52	90	12	150	158	150	8	5,0																			
125	315	250	33	8	M30	139,7	141,5	-	-	42	40	40	40	-	-	105	56	105	12	180	188	185	8	6,3																			
150	355	290	33	12	M30	168,3	170,5	-	-	48	44	44	44	-	-	130	60	115	12	210	225	216	10	7,1																			
200	430	360	36	12	M33	219,1	221,5	-	-	60	52	52	52	-	-	180	-	130	16	278	-	278	10	10,0																			
250	505	430	39	12	M36	273,0	276,5	-	-	72	60	60	60	-	-	210	-	157	18	340	-	340	12	12,5																			
300	585	500	42	16	M39	323,9	327,5	-	-	84	68	68	68	-	-	260	-	170	18	400	-	407	12	14,2																			
350	655	560	48	16	M45	355,6	359,5	-	-	95	74	74	74	-	-	300	-	189	20	460	-	460	12	16,0																			
400	715	620	48	16	M45	406,4	411,0	-	-	406	-	78	-	-	-	-	-	-	-	-	-	518	-	-																			
500	870	760	56	20	M52	508,0	543,5	-	-	128	-	94	-	-	-	-	-	-	-	-	-	630	-	-																			

Note 1: Dimensions N1, N2 and N3 are measured at the intersection of the hub draft angle and the back face of the flange.